

Medical IT System Insulation Monitoring and Fault Locating Devices

(6-Piece Set)

Installation and Operation Manual V1.3

Declaration

Please read this instruction carefully before using this product. All pictures, logos and symbols involved are owned by Acrel Co., Ltd. All or part of the content shall not be reproduced publicly without written authorization by non-company personnel.

Please read the instructions and precautions in this operation manual carefully before using this series of products. Acrel will not be responsible for personal injury or economic loss caused by ignoring the instructions in this operation manual.

The equipment is professional electrical equipment, any related operation, need to be carried out by special electrical technicians. Acrel is not responsible for personal injury or financial loss resulting from the error of non-professional personnel.

The contents of this description will be updated and amended constantly, and it is inevitable that there will be a slight discrepancy between the physical product and the description in the product function upgrading. Please refer to the physical product purchased and obtain the latest version of the description through www.acrel-electric.com or sales channels.

Contents

1 Introduction.....	1
2 Function Features.....	2
2.1 Function Features of AITR series Medical Isolation Transformer.....	2
2.2 Function Features of AIM-M300/SG Insulation Monitor.....	2
2.3 Function Features of AIL150/160 Insulation Fault Locator.....	3
2.4 Function Features of AID150/200 Alarm and Display Device.....	3
2.5 Function Features of HDR-60-24 DC Power Supply.....	3
2.6 Function Features of AKH-0.66P26 Current Transformer.....	3
3 Reference Standard.....	3
4 Technical Parameters.....	4
4.1 Technical Parameters of AITR series Medical Isolation Transformer.....	4
4.2 Technical Parameters of AIM-M300/SG Insulation Monitoring Device.....	5
4.3 Technical Parameters of AIL150/160 Insulation Fault Locator.....	5
4.4 Technical Parameters of AID150/200 Alarm and Display Device.....	5
4.5 Technical Parameters of HDR-60-24 DC Power Supply.....	6
4.6 Technical Parameters of AKH-0.66P26 Current Transformer.....	6
5 Installation and Wiring.....	6
5.1 Shape and Mounting Hole Size.....	6
5.2 Installation Method.....	9
5.3 Wiring Method.....	11
5.4 Typical Wiring Diagram.....	15
5.5 Considerations.....	17
6 Programming and Application.....	18
6.1 Panel Description.....	18
6.2 LED Indicator Instructions.....	19
6.3 Button Function Descriptions.....	20
6.4 Button Operation Descriptions.....	20
7 Communication Protocol.....	26
7.1 Modbus-RTU Communication Protocol.....	26
7.2 Introduction of Function Code.....	26
7.3 Parameter Address Table of AIM-M300/SG.....	27
7.4 CAN Communication Description.....	28
8 Typical Applications.....	28
9 Powerup and Debugging Instructions.....	30
9.1 Wiring Check.....	30
9.2 Common Faults and Eliminations.....	30
9.3 Settings and Debugging.....	31

Medical IT System Insulation Monitoring and Fault Locating Devices



1 Introduction



Medical IT systems are mainly used in important group 2 medical places such as operating rooms, ICU/CCU intensive care units, etc. to provide safe, reliable and continuous power distribution for important equipment in these places.

The medical insulation monitoring and fault location device is developed by Acrel based on years of design experience in the power device industry and the special requirements of insulation monitoring and fault location for power distribution systems in medical group 2 locations. The product can realize real-time monitoring of IT system insulation, load and isolation transformer temperature, etc., system insulation fault circuit location and centralized monitoring of multiple systems.

Medical IT system insulation monitoring and fault location products (6-Piece Set) include AITR series medical isolation transformer, AIM-M300/SG insulation monitor, AKH-0.66P26 current transformer, AIL150-4/AIL150-8/AIL160-6 insulation fault locator, HDR-60-24 DC power supply module and AID150/200 centralized alarm and display device, etc. The products are shown in Table 1.

Table 1 Medical IT System Insulation Monitoring and Fault Locating Products

Model and Name	Picture	Description
AITR series Isolation Transformers		AITR series isolation transformers are specialized in medical IT systems. The iron core is made of stacked silicon steel wafers imported from Japan with very low loss. Double insulation treatment is adopted between windings and electrostatic shielding layer is provided to reduce electromagnetic interference between windings. A Pt100 temperature sensor is installed in the wire package for monitoring the transformer temperature. The whole is treated with vacuum dipping paint, which increases the mechanical strength and corrosion resistance. The product has very good temperature rise performance and very low noise.
AIM-M300/SG Medical Intelligent Insulation Monitor (IMD)		AIM-M300/SG medical intelligent insulation monitor adopts advanced micro-controller technology with high integration, compact size, easy installation, integrating intelligence, digitization and networking, and is suitable for insulation monitoring and fault localization of isolated power supply system in medical group 2 places, such as operating rooms, intensive care units and so on.
AKH-0.66P26 Current Transformer		AKH-0.66P26 current transformer is a protection type current transformer used with AIM-M300/SG insulation monitor, the maximum measurable current is 60A, the ratio is 2000:1, the CT is mounted inside the cabinet with screws fixed directly, and the secondary side is led out, which is easy to install and use.

<p>AIL150-4/ AIL150-8/ AIL160-6 Insulation Fault Locators (IFL)</p>		<p>AIL150-4/AIL150-8/AIL160-6 insulation fault locators use high sensitivity transformers with high precision signal detection circuitry to detect the signals injected into the system by the AIM-M300/SG Medical Intelligent Insulation Monitors, and to accurately locate the circuits where the insulation faults are located. The AIL150-4 Insulation Fault Locator can locate insulation faults in 4 circuits, the AIL150-8 Insulation Fault Locator can locate insulation faults in 8 circuits, and the AIL160-6 Insulation Fault Locator can locate insulation faults in 6 circuits. Insulation fault location can be used in combination with up to 24 circuits for the AIL150 series and up to 48 circuits for the AIL160 series.</p>
<p>HDR-60-24 DC Power Supply</p>		<p>HDR-60-24 DC power supply can simultaneously provide DC 24V power supply for devices such as AIM-M300/SG Medical Intelligent Insulation Monitor, AIL150/160 Series Insulation Fault Locator and AID150/200 Centralized Alarm and Display device. With high power, stable voltage output and easy installation, this power supply can meet the power supply requirements of the above devices and is a recommended power supply product.</p>
<p>AID150/200 Centralized Alarm and Display Device</p>		<p>AID150/200 centralized alarm and display instrument adopts LCD liquid crystal display, and uses RS485/CAN communication interface to exchange data and information with AIM-M300/SG medical intelligent insulation monitor, AID150/200 can monitor the data of up to 16 AIM-M300/SG insulation monitors in real time.</p>

2 Function Features

2.1 Function Features of AITR series Medical Isolation Transformer

- Core component of a medical IT system for converting TN into IT system (ungrounded system);
- The transformation ratio between the primary and secondary windings is 1:1;
- Double insulation treatment is adopted between the windings, shielding layer is designed;
- The Pt100 temperature sensor is installed in each wire packet to monitor the temperature.

2.2 Function Features of AIM-M300/SG Insulation Monitor

- Function of real-time monitoring and fault alarm for the monitored IT system ground insulation resistance, transformer load current and transformer winding temperature;
- It can real-time monitor the faults of disconnection of connecting line with the measured system, current transformer disconnection fault, temperature sensor disconnection fault and functional grounding line disconnection fault, and give alarm indication within 2s after the fault occurs;
- Relay alarm output, LED alarm indication and other fault indication functions;

- It can generate positioning signals to be injected into the IT system, initiate fault positioning, and display the positioning results;
- It adopts two fieldbus communication technologies, RS485 bus and CAN bus, for communication with centralized alarm and display device, insulation fault locator and upper computer management software, which can remotely monitor the operation of IT system in real time;
- SOE (Sequence of Event) function, recording the time of alarm occurrence and the type of fault, which is convenient for operators to analyze the system operation status and eliminate faults in time.

2.3 Function Features of AIL150/160 Insulation Fault Locator

- It can cooperate with AIM-M300/SG Medical Intelligent Insulation Monitor to realize the fault location function. The localization results are indicated by the LEDs of the corresponding circuits.
- It adopts CAN bus technology, it can interact data with other devices;

2.4 Function Features of AID150/200 Alarm and Display Device

- Remotely monitor the real-time operation conditions of up to 16 pieces of systems, and the main interface intuitively displays whether the access system communication is intact;
- The insulation resistance alarm value, load current alarm value and transformer temperature alarm value of each system insulation monitoring device can be set up remotely, and the insulation monitor self-test can be activated remotely;
- When there are insulation faults, overload, excessive temperature rise of the voltage transformer or wiring faults in any of the monitored system, centralized alarm and display device can provide corresponding sound and light alarm function, and can manually eliminate the alarm sound;
- Sequence of events (SOE) function, which is convenient for users to analyze the operation conditions of system and promptly eliminate the faults, and can save maximum of 20 newest records.

2.5 Function Features of HDR-60-24 DC Power Supply

- It used for the DC 24V power supply for AIM-M300/SG insulation monitoring device, AIL150/160 series insulation fault locator, AID150/200 centralized alarm and display device and other devices;
- AC 220V input, DC 24V output, with max output power of 60W.

2.6 Function Features of AKH-0.66P26 Current Transformer

- Work with the AIM-M300/SG insulation monitoring device to measure the load current;
- The maximum measurable current is 60A, and the transformation change ratio is 2000:1.

3 Reference Standard

- IEC 60364-7-710 *Building electrical installations section 7-710: Requirements for special installations or locations----medical locations;*
- IEC 61557-8 *Electrical safety of low voltage distribution system below AC 1000V and DC 1500V, Test, measurement or monitoring equipment for protection test section 8: Insulation monitoring device for IT systems;*

■ IEC 61557-9 *Electrical safety of low voltage distribution system below AC 1000V and DC 1500V, Test, measurement or monitoring equipment for protection test section 9: insulation fault positioning equipment for IT systems;*

■ IEC 61558-1 *Safety of power transformers, power supplies, reactors and similar products section 1: General requirements and tests;*

■ IEC 61558-2-15 *Safety of power transformers, power supplies and similar products section 16: Special requirements for isolation transformers for power supply in medical locations.*

4 Technical Parameters

4.1 Technical Parameters of AITR series Medical Isolation Transformer

Refer to Table 2.

Table 2 Technical Parameters of AITR Series of Medical Isolation Transformer

Item	AITR10000S	AITR8000S	AITR6300S	AITR5000S	AITR3150S
Insulation class	F	F	F	F	F
Protection class	IP00	IP00	IP00	IP00	IP00
Power/voltage/current					
Rated power	10000VA	8000VA	6300VA	5000VA	3150VA
Rated frequency	50~60Hz	50~60Hz	50~60Hz	50~60Hz	50~60Hz
Rated input voltage	AC230V	AC230V	AC230V	AC230V	AC230V
Rated input current	45.3A	36A	28.5A	22.5	14.2A
Rated output voltage	AC230V/115V	AC230V/115V	AC230V/115V	AC230V/115V	AC230V/115V
Rated output current	43.5A	34.7A	27.4A	21.7	13.7A
Inrush current	<12In	<12In	<12 In	<12 In	<12In
Leakage current	<500μA	<500μA	<500μA	<500μA	<500μA
No load input current	1.359A	1.08A	0.855A	0.675A	0.426A
No load output voltage	234V±3%	234V±3%	234V±3%	234V±3%	234V±3%
Short circuit voltage	<9.2V	<9.2V	<9.2V	<9.2V	<9.2V
General parameters					
Fuse wire	80A	63A	50A	35A	25A
Primary winding resistance	<55mΩ	<64mΩ	<80mΩ	<131 mΩ	<245mΩ
Secondary winding resistance	<45mΩ	<64mΩ	<80mΩ	<116 mΩ	<228mΩ
Iron loss	<80W	<65W	<60W	<50W	<30W
Copper loss	<450W	<345W	<277W	<255W	<175W
Efficiency	>96%	>96%	>96%	>96%	>95%
Maximum ambient temperature	<40°C	<40°C	<40°C	<40°C	<40°C
No-load temperature rise	<80K	<80K	<80K	<80K	<80K
Full load temperature rise	<40dB	<40dB	<40dB	<40dB	<40dB

4.2 Technical Parameters of AIM-M300/SG Insulation Monitoring Device

Refer to Table 3.

Table 3 Technical Parameters of AIM-M300/SG Insulation Monitoring Device

AUX Power	Voltage	DC 18~36V	Locate Signal	Locate voltage	≤12V
	Power consumption	≤6W		Locate current	≤1mA (peak)
Insulation Monitoring	Resistance range	15~999kΩ	Alarm Output	Output mode	2 output relay
	Response value	50~999kΩ		Contact rating	AC 250V/3A DC 30V/3A
	Relative uncertainty	±10%	Communication Protocol	Communication 1	RS485, Modbus-RTU
	Response time	≤3s		Communication 2	CAN, customized
	Permissible system leakage capacitance	≤5μF	Environment	Operating temperature	-10~+55°C
	Allowed external voltage Ufg	≤ DC 280V		Transport temperature	-25~+70°C
	Measuring voltage	≤13V		Storage temperature	-25~+70°C
	Measuring current	≤50μA		Relative humidity	<95%, No condensation
	Impedance Zi	≥240kΩ	Altitude	<2500m	
Current Monitoring	Measuring Value	2.1~60A	Insulation Method		guide
	Measuring accuracy	±5%	Display Method		LCD, LED
	Alarm Value	5~80A	Fault Record		20
Temperature Monitoring	Thermal resistor	two Pt100	IP degree		IP40
	Measuring range	-50~+200°C	Rated voltage / pollution degree		4KV/III
	Alarm value range	0~+200°C	EMC/EMR		IEC 61326-2-4

4.3 Technical Parameters of AIL150/160 Insulation Fault Locator

Refer to Table 4.

Table 4 Technical Parameters of AIL150-4/AIL150-8/AIL160-6 Insulation Fault Locator

Items		Technical Parameters
AUX Power	Rated voltage	DC 18~36V
	Maximum power consumption	≤2VA
Monitored system	Rated voltage	AC 0~242V
	Rated frequency	45~60Hz
Fault locating	Maximum circuit	4 loop, 8 loop, 6 loop
	Response time	≤5s
Communication	Mode	CAN
	Protocol	customized

4.4 Technical Parameters of AID150/200 Alarm and Display Device

Refer to Table 5.

Table 5 Technical Parameters of AID150/200 Alarm and Display Device

Item		Technical parameters
Auxiliary power supply	Voltage	DC 24V
	Consumption	< 0.6W
Number of IT systems monitored		16
Insulation resistance alarm setting		10~999kΩ
Load current alarm setting		0~99A
Over-temperature alarm setting		0~200°C

Installation mode	Embedded in wall, rail, panel
Alarm mode	Sound-light alarm
Alarm type	Insulation fault, overload, overheat, equipment fault
Communication mode	RS485 interface, Modbus-RTU protocol
Display mode	LCD display, 128*64 dot array

4.5 Technical Parameters of HDR-60-24 DC Power Supply

Refer to Table 6.

Table 6 Technical Parameters of HDR-60-24 DC Power Supply

Items		Technical Parameters
AUX Power	Input	AC 100~240V 1.8A
	Output	DC 24V 2.5A
Installation method		35mm guide installation

4.6 Technical Parameters of AKH-0.66P26 Current Transformer

Refer to Table 7.

Table 7 Technical Parameters of AKH-0.66P26 Current Transformer

Input current	0.5mA~50A	Frequency range	0.02~10 kHz
Output current	0.025~25 mA	Loading resistance	<200Ω
Temperature coefficient	100 ppm/°C	Transient current (1s)	200A
Phase displacement	10'	Installation	Fixed with 4×10 screws
Operating temperature	-35~+70°C	Secondary wiring	Shielded twisted pair cable 2*0.3mm ² , 2m, customized
Storage temperature	-40~+75°C		
Resistance range	95~120Ω	Isolation pressure	5000Vac
Accuracy	0.5%	Linearity	0.5%

5 Installation and Wiring

5.1 Shape and Mounting Hole Size

5.1.1 External Dimensions of AITR series Medical Isolation Transformer (unit: mm)

Shape structure and size of AITR series medical isolation transformer are shown as below and in Table 8 (unit: mm)

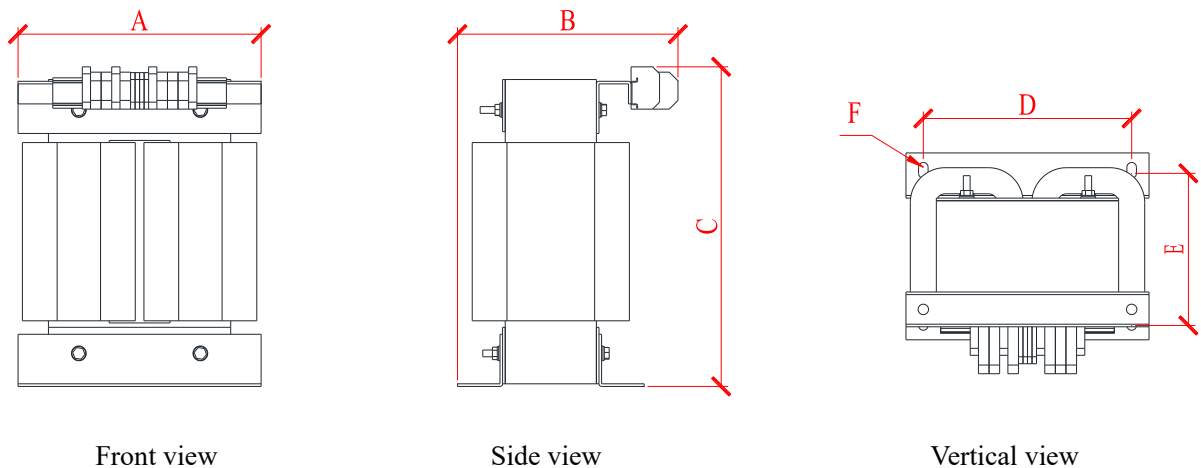
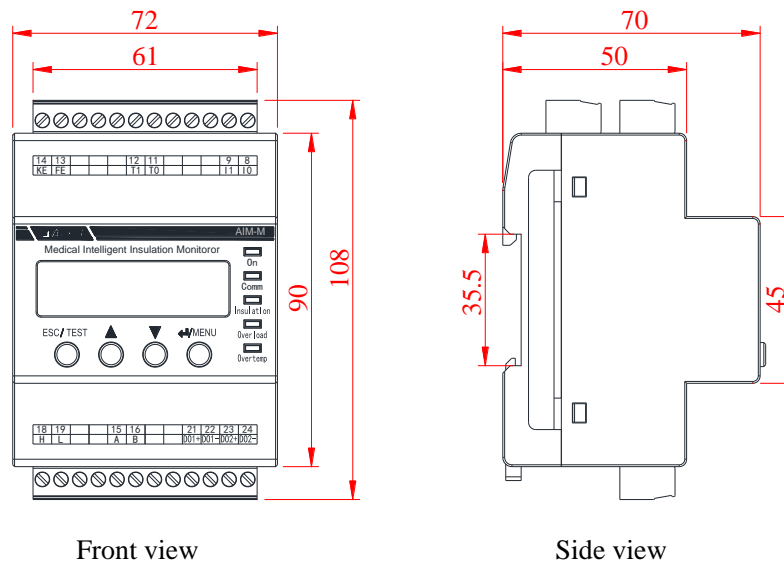

Table 8 External Dimensions of AITR series Medical Isolation Transformer

Product Model	Capacity (VA)	Overall dimension (mm)			Mounting dimension (mm)			Weight (kg)
		A	B	C	D	E	F	
AITR10000S	10000	280	236	421	240	190	11*8	86±5
AITR8000S	8000	280	236	421	240	190	11*8	79±5
AITR6300S	6300	280	221	421	240	175	11*8	69±5
AITR5000S	5000	280	211	421	240	175	11*8	62±5
AITR3150S	3150	280	211	421	240 <td 175	11*8	49±5	

Note: According to the standard, the maximum capacity of medical single-phase isolation transformer is 10kVA; Dimensions A, B, and C are the length, width, and height of the transformer; dimensions D, E, and F are the installation dimensions of the transformer; F is the mounting hole position. M8*30 screws are recommended to fix the transformer.

5.1.2 External dimensions of AIM-M300/SG Insulation Monitoring Device (unit: mm)



Front view

Side view

5.1.3 External dimensions of AIL150/160 Insulation Fault Locator (unit: mm)

The external dimensions of the AIL150-4/AIL150-8 products are shown below.

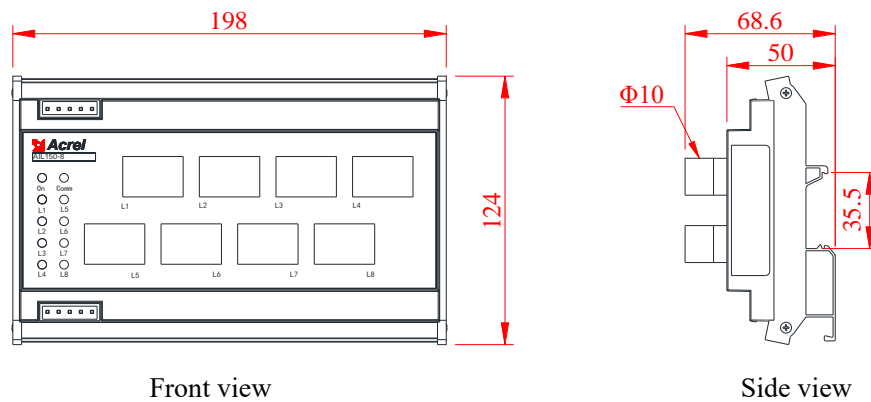

Front view

Side view

Note: AIL150-4 and AIL150-8 have the same shell and different number of transformers.

The external dimensions of the AIL160-6 product are shown below.

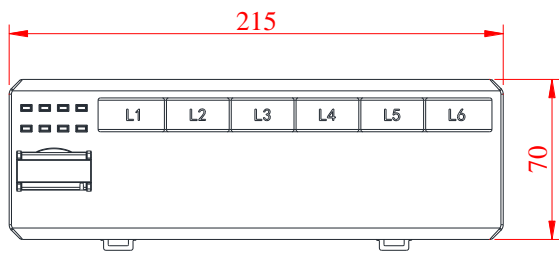

Front view

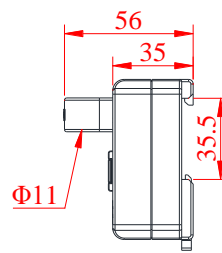

Side view

5.1.4 External dimensions of AID150/200 Centralized Alarm and Display Device (unit: mm)

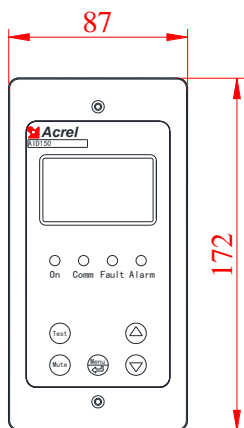

Front view

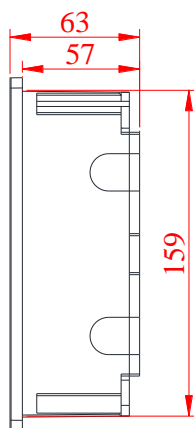

Side view

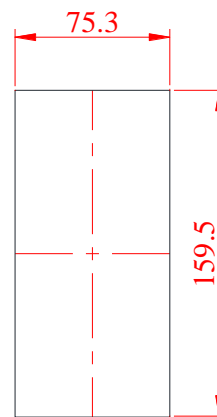

Hole size

5.1.5 External dimensions of HDR-60-24 DC Power Supply (unit: mm)

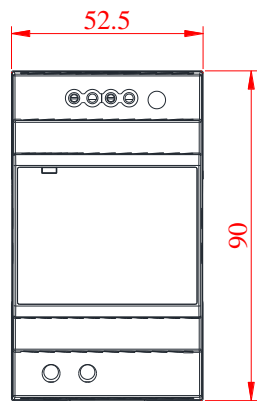

Front view

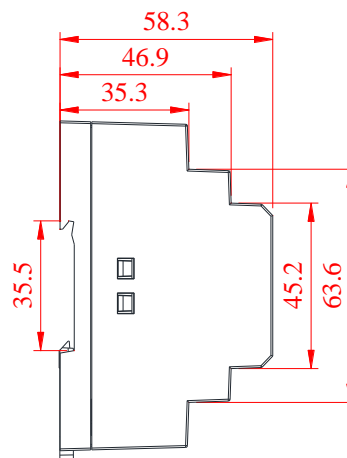

Side view

5.1.6 External dimensions of AKH-0.66P26 current transformer (unit: mm)

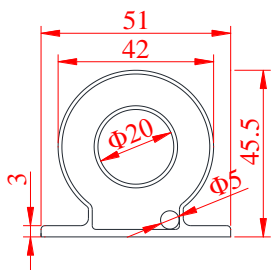

Front view

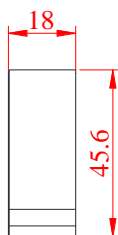

Side view

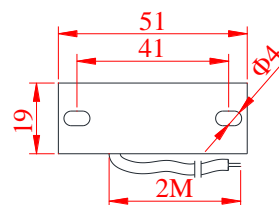

Bottom view

5.2 Installation Method

Medical IT system insulation monitoring and fault location device and other six-piece products in addition to the AID150/200 centralized alarm and display device, preferably centralized installation in the distribution cabinet (isolation power cabinet), the isolation transformer is installed in the bottom of the distribution cabinet, with matching bolts fixed, and installed cooling fan. The device and circuit breakers are mounted on the upper panel. If the isolation transformer is installed separately, AIM-M300/SG insulation monitor should be installed nearby. AID150/200 centralized alarm and display device if used in the operating room, can be installed on the wall next to the information panel in the operating room, so that the medical staff can view, if used in ICU/CCU and other intensive care units, should be installed in the nurse's station, for the nurses on duty to view. AID150/200 external wiring includes two 24V power lines and a 2-core shielded twisted-pair RS485 communication line, these three lines are drawn from the isolated power cabinet, the construction should pay attention to the reserved pipeline.

5.2.1 Installation method of AIM-M300/SG Medical Intelligent Insulation Monitoring Device

The AIM-M300/SG insulation monitor is rail mounted as shown in the figure below:

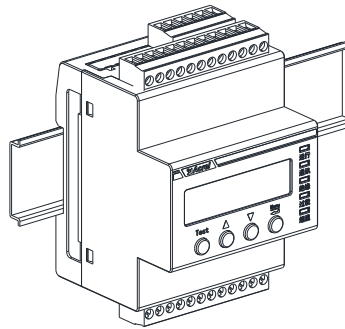

5.2.2 Installation method of HDR-60-24 DC Power Supply

The HDR-60-24 power supply module is rail-mounted with snap-in fasteners and can be mounted side-by-side on the same rail as the AIM-M300/SG insulation monitor.

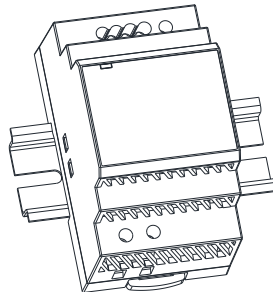

5.2.3 Installation method of AIL150/160 Insulation Fault Locator

The AIL150/160 is rail-mounted and fixed by means of snap fasteners. Since each branch circuit of the IT system has to pass through the transformers of AIL150/160 before connecting to the load, it is recommended that AIL150/160 be installed close to the outlet end of each branch circuit for ease of wiring.

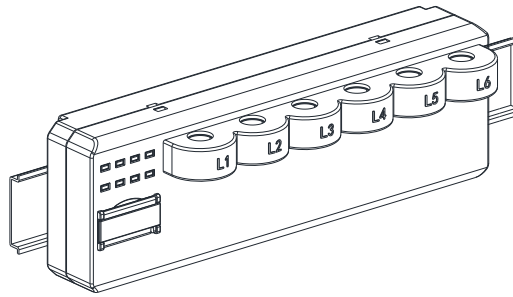

5.2.4 Installation mode of AID150/200 Centralized Alarm and Display Device

(1) If the AID150/200 centralized alarm and display device is embedded in the wall, the installation schematic is shown below:

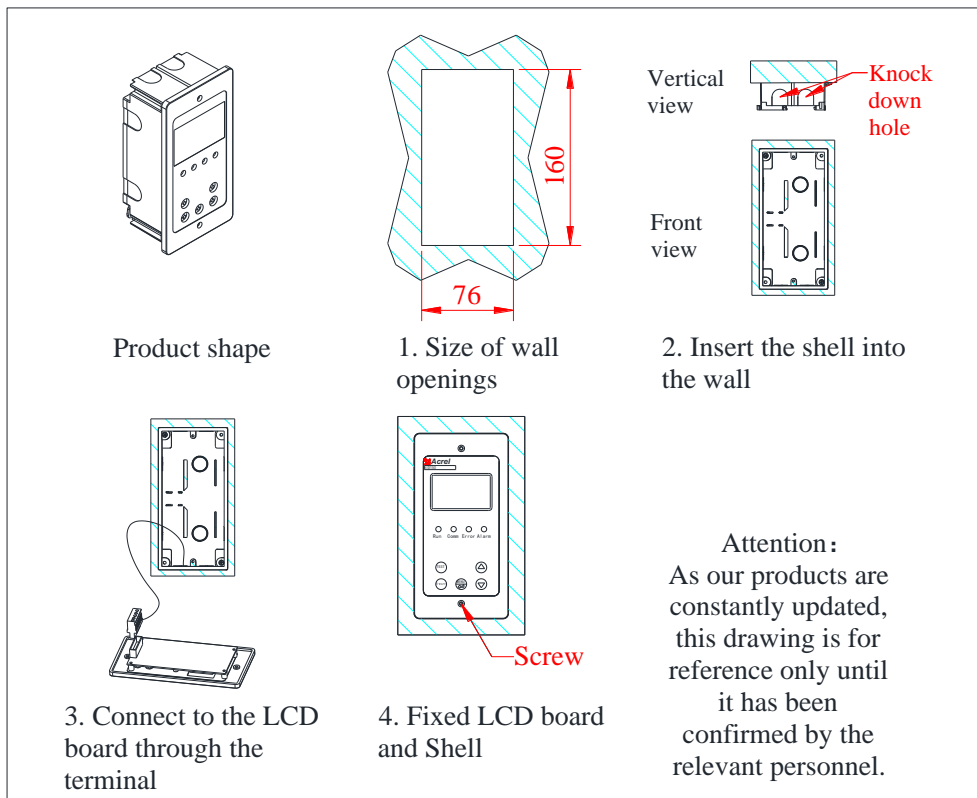

When decorating, first open the opening in a suitable wall position, then introduce the isolated power cabinet wires (two 1.5mm² power cables and one 2*1.5mm² shielded twisted pair) to receive the terminals, knock out the knockout holes of the shell near the pipeline, then embed the external alarm and display device shell into the wall body for fixing, and then connect the terminals to the corresponding terminals of the front cover wiring board, and then install the panel in the shell, and then fix it by using the supplied Tighten the self-tapping screws to fix it.

(2) If the AID150/200 is installed by using the cabinet door opening, the installation schematic is shown below:

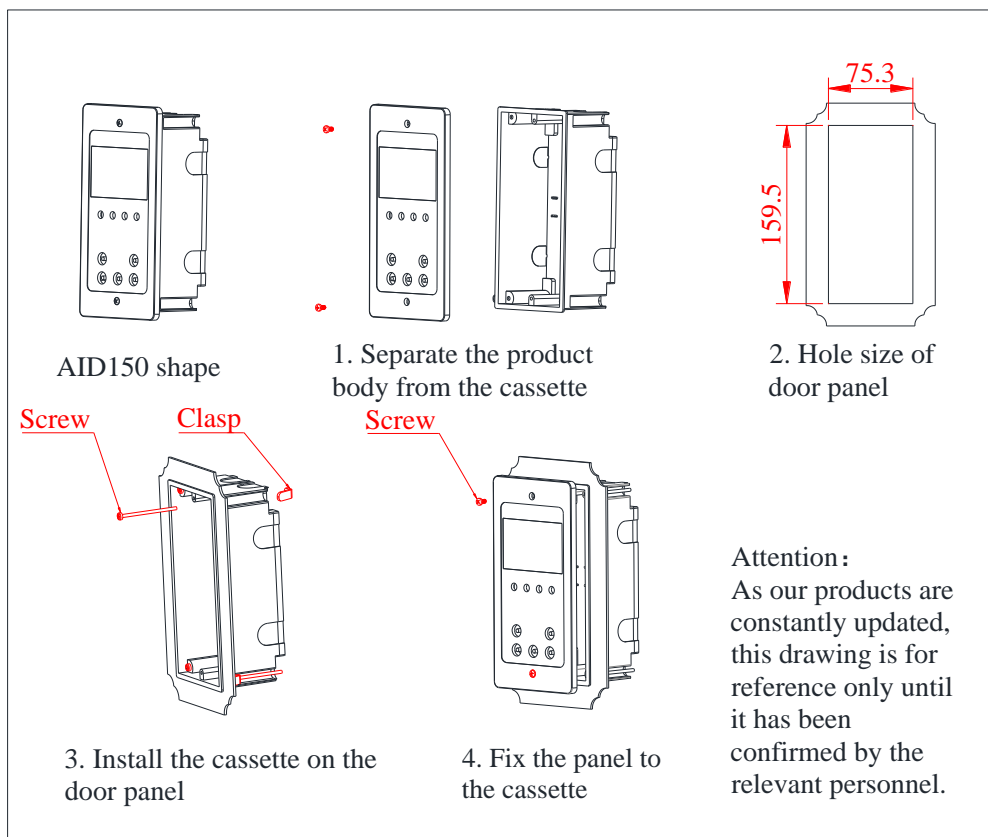

5.3 Wiring Method

5.3.1 Wiring Method of AITR series Medical Isolation Transformer

At the transformer terminals, the one labeled "PM" is the input terminal, in which the two terminals 0 and 230 are connected to the input 220V single-phase AC power, and the one labeled "SEC" is the output terminal, in which the two terminals 0 and 230 are connected to the output voltage of 220V AC for external load. The terminal labeled "SEC" is the output terminal, in which the two terminals 0, 230 output voltage is 220V AC, external loads, S terminal is connected to the field PE bus (or equipotential terminal block). The two ST terminals are temperature sensor interfaces, which are connected to terminals 11 and 12 of the AIM-M300/SG insulation monitor.

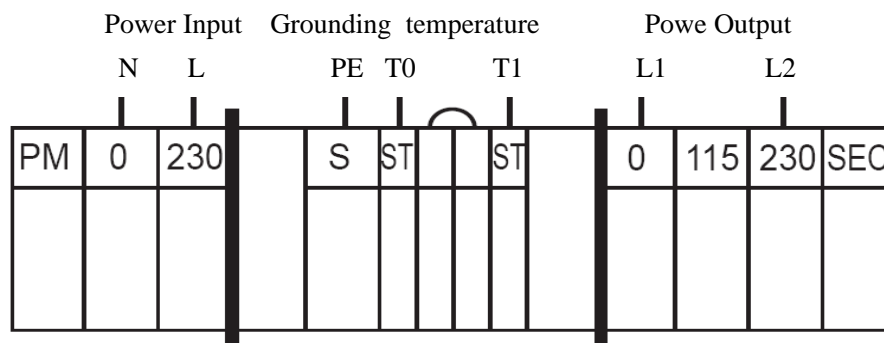

Note: isolation transformer input and output wiring, should be based on the isolation transformer rated input and output current to select the matching wire diameter of copper wire (see the back of the 5.4 part of the table). 2*4mm² yellow and green wires can be used for the ground of the S-terminal wiring. The wiring of the two ST terminals can choose 2*1.5mm² shielded twisted pair, and the wiring should not be too long.

5.3.2 Wiring methods of AIM-M300/SG Insulation Monitor

Upper row of terminals: 24V, G for the auxiliary power supply, L1, L2 and the monitored IT system connection (can be connected to the two outputs of the isolation transformer), I0, I1 for the signal input of the current transformer, T0, T1 for the signal input of the temperature sensor, FE, KE for the function of the grounding line, wiring should be used to connect the two independent of each other and the site of the equipotential terminal block.

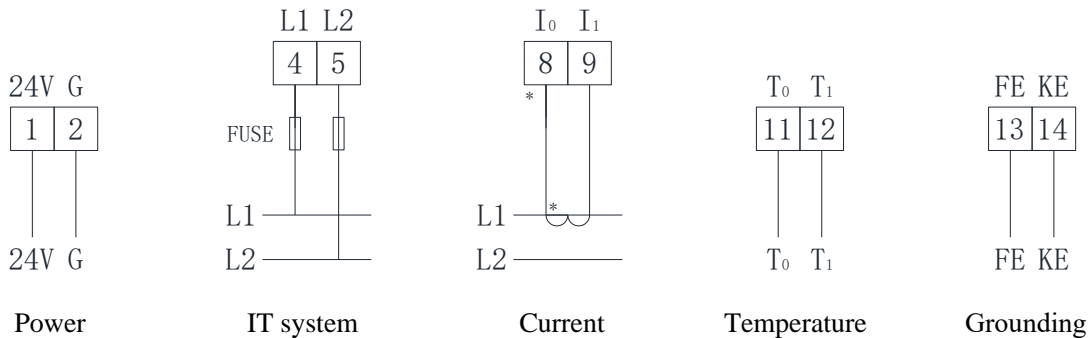

Lower row of terminals: A, B for RS485 communication terminals (for and AID150 centralized alarm and display device communication connection), H, L for CAN communication terminals (for and AIL150/160 series of insulation fault locator, AID200 centralized alarm and display device communication connection), DO1 for the over-temperature alarm output (for the control of cooling fan), DO2 for the fault alarm relay output.

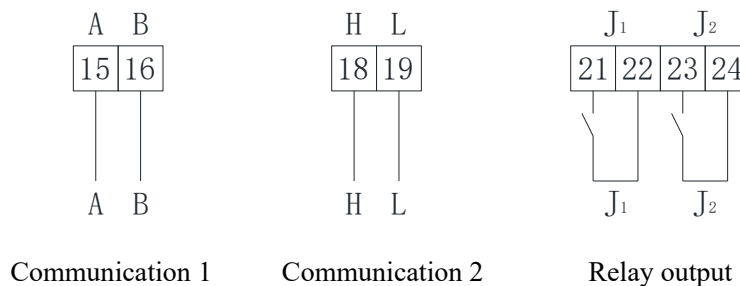

Notes:

(1) Insulation monitor 1, 2 terminals connected to the 24V power supply wiring can be selected 2*1.5mm² copper wire, 4, 5 corresponds to the L1 and L2 terminals, you can choose 2*1.5mm² multi-stranded copper wire, 13, 14 corresponds to the FE and KE terminals, you can choose 2*4mm² yellow and green wire (ground wire). J1, J2 relay output is a dry node, the control of external loads need J1, J2 relay output is a dry node, when controlling external loads need to add another power supply, such as J1 control AC 220V cooling fan, need to add AC 220V power supply, wiring type according to the load current to determine.

(2) Terminals 8 and 9 correspond to the current transformer line, terminals 11 and 12 correspond to the temperature line, terminals 15 and 16 correspond to the RS485 communication line, and terminals 18 and 19 correspond to the CAN communication line, which can be selected from 2*1.5mm² shielded twisted-pair cable.

5.3.3 Wiring method of AIL150/160 Insulation Fault Locator

The AIL150-4/AIL150-8 insulation fault locator terminals are shown below:

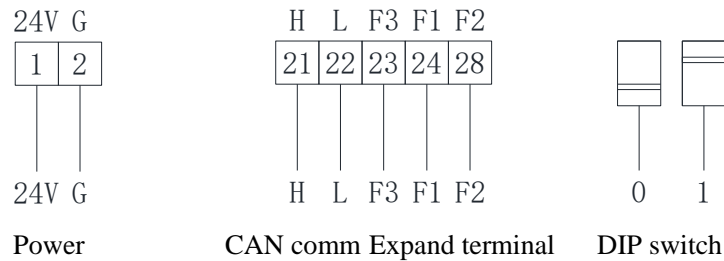

Upper row terminals (1, 2): 24V, G for auxiliary power.

Lower row of terminals (21~22): H, L for CAN communication terminals (used and medical intelligent insulation monitor, centralized alarm and display device communication terminal connection). Lower row of terminals (23, 24, 28): F1, F2, F3 are used as insulation fault locator circuit expansion function. When the number of circuits to be located in an IT system exceeds 8 circuits, 2 (or 3) AIL150 series insulation fault locators can be used at the same time to locate up to 24 circuits. When 3 AIL150s are used, the second one should short F1 and F2 terminals to make the number of branch circuits become 9~16 circuits; the third one should short F3 and F1 terminals to make the number of branch circuits become 17~24 circuits.

AIL160-6 terminals are as follows:

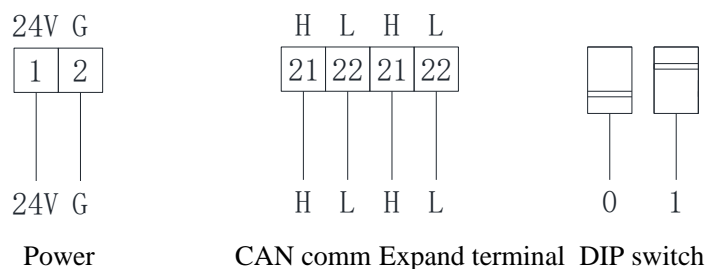

Lower row terminals (1, 2): 24V, G for auxiliary power. Lower row terminals (21, 22): H, L are CAN communication terminals (used to connect with the communication terminals of insulation monitor, alarm and display), and the two sets of CAN communication terminals are connected.

AIL160 adopts the way of dialing code switch to use the extended function, the position of 8~10 digit dialing code can set the circuit status, when 8~10 for the dialing code for 000, the positioning circuit defaults to 1~6 way; when the dialing code for 001, the positioning circuit for 7~12, and so on, when the dialing code for 111, the positioning circuit for 43~48, as shown in Table 9.

Table 9 AIL160 DIP Switch Settings

DIP Switch Setting										
1	2	3	4	5	6	7	8	9	10	
DIP Setting		Reserved					Loop Setting			
1	2	Resistance			8	9	10	Loop Setting		
0	0	Without			0	0	0	L1~L6		
0	1				0	0	1	L7~L12		
1	0	With				
1	1				1	1	1	L43~L48		

Note: 1: On 0: off

AIL150/160 series fault locators have a built-in 120Ω matching resistor. When the communication

line is too long or interference causes communication anomalies, the matching resistor can be accessed by setting the dip switch. When one AIL150/160 fault locator is used in the field and the CAN communication is abnormal, it can be connected to the end of the communication bus, and at the same time, the corresponding matching resistor dip switch can be set to "1" position, and then a 120Ω matching resistor can be connected in parallel at the first end of the bus. When two or more AIL150/160 fault locators are used in the field, and the CAN communication is abnormal, two of them can be connected to the first and the last end of the communication bus, and at the same time, the corresponding matching resistor dip switches can be set to position "1", and then the corresponding dip switches can be set according to the circuit.

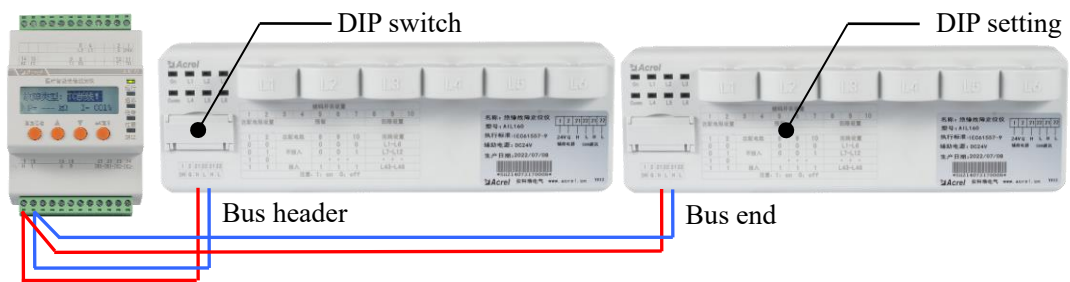

5.3.4 Wiring method of AID150/200 Centralized Alarm and Display Device

Terminals A and B of AID150 are connected to A and B in the AIM-M300/SG meter terminals respectively. The power supply terminals are connected to the positive pole and ground of the 24V DC power supply correspondingly, and the wiring diagram is shown below.



When an AID150 is required to access multiple AIM-M300/SG Medical Intelligent Insulation Monitors, all device communication A and B communication terminals should be connected by hand, and if the communication distance is too long or the communication is abnormal, a 120Ω matching resistor should be accessed in parallel at the first and last ends of the communication, as shown in the following figure:

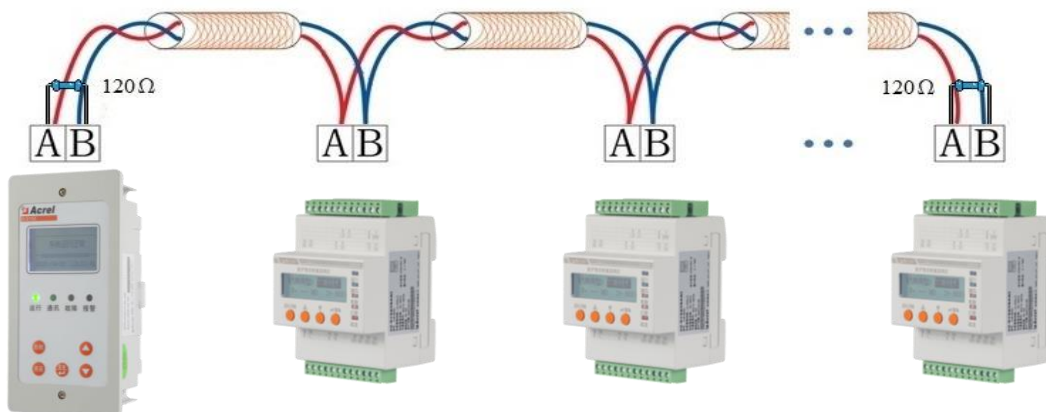

The H and L terminals of AID200 are connected to the H and L in the AIM-M300/SG meter terminals respectively. The power supply terminals are connected to the positive pole and ground of the 24V DC power supply correspondingly, and the wiring diagram is shown below.



When an AID200 is needed as a local display mounted on the wall in the operating room, it can be connected to the CAN bus. As shown in the figure below:

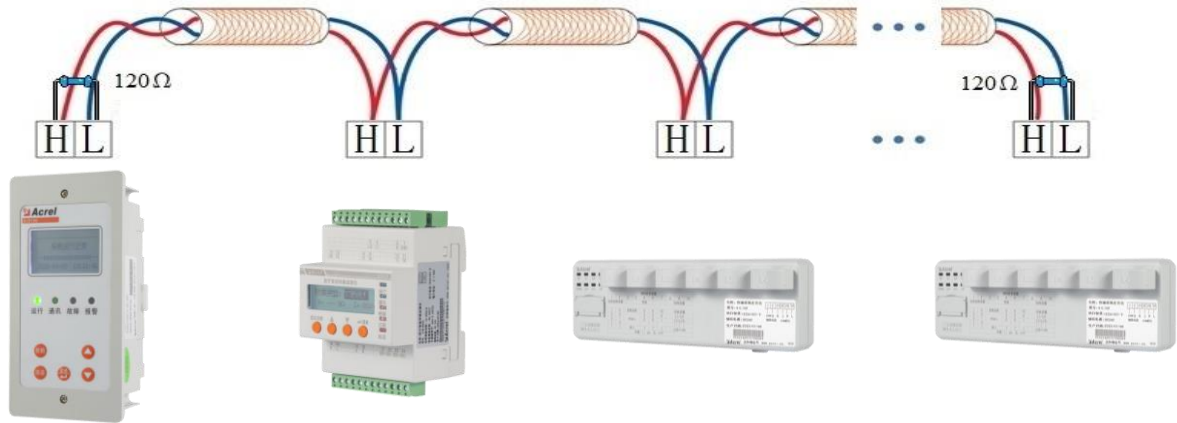

The 24V power supply of AID150/200 centralized alarm and display device can be connected with 2*1.5mm² multi-stranded copper wire; 2*1.5mm² shielded twisted-pair wire can be used for external wiring of RS485 communication terminal.

5.4 Typical Wiring Diagram

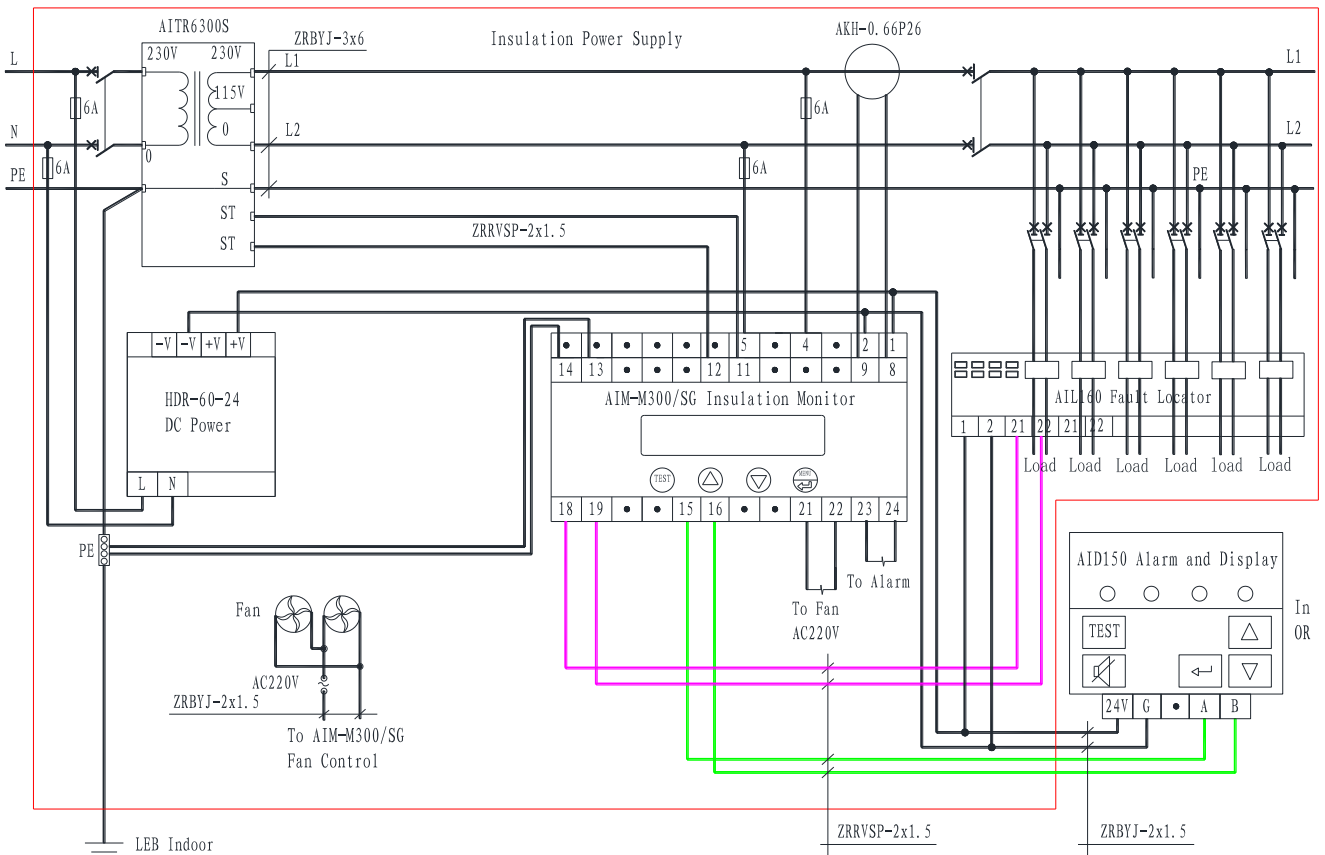

More information:

(1) The connection line diameter of the input and output of the isolation transformer should match the rated current of the isolation transformer, or it can be selected according to the following table:

Isolation Transformer Model	Selected line diameter
AITR3150S	3*4 mm ²
AITR5000S/AITR6300S	3*6 mm ²
AITR8000S/AITR10000S	3*10 mm ²

(2) The auxiliary power supply (instrument working power) of AIM-M300/SG insulation monitor (corresponding terminals: No. 1 and No. 2), AIL150/160 insulation fault locator (corresponding terminals: No. 1 and No. 2), and AID150/200 centralized alarm and display instrument (corresponding terminals: No. 24V and No. G) are all DC 24V, which are supplied uniformly by the HDR-60-24 DC power module (24V output terminals: No. 3 and No. 4). Output terminals: No. 3, 4) to unify the power supply. Considering that the switching power supply may cause interference to the IT system, the input AC 220V of the DC power supply module (corresponding terminals: No. 1 and No. 2) is introduced from the input of the isolation transformer and is protected by a series of 6A fuses. terminals No. 4 and No. 5 of the AIM-M300/SG Insulation Monitor are for the insulation monitoring of the IT system, which can be accessed to the back end of the single-phase isolation transformer of medical equipment, and it is appropriate to connect a series of 6A-rated fuses for protection. AIM-M300/SG insulation monitor No. 13, 14 for the grounding terminal, two independent grounding wire should be used to connect to the site of the equipotential terminal block (or grounding terminal block in the isolated power cabinet).

(3) AIM-M300/SG insulation monitor 8, 9 terminals for current monitoring, access to AKH-0.66P26 current transformer, the transformer only through the medical single-phase isolation transformer secondary side output L1, L2 any of the two wires can be, can not be threaded at the same time into the two wires. Current transformer lead wiring into the corresponding terminal, the shield is not grounded.

(4) AIM-M300/SG insulation monitor 11, 12 terminals for temperature monitoring, access to the temperature sensor, the transformer internal temperature sensor leads to the ST terminal.

(5) Terminals 18 and 19 of the AIM-M300/SG insulation monitor are CAN communication terminals, which need to be connected with terminals 21 and 22 of the AIL150/160 in a hand-to-hand manner (i.e., the communication line of the previous meter is connected to the communication terminals of this meter, and then led out from the terminals of this meter to the communication terminals of the following meter), and the AIL150/160 fault locator should be AIL150/160 Fault Locator should be installed in a suitable position to facilitate the load outgoing wires from each branch circuit (excluding PE wires) to pass through the corresponding transformer of the Fault Locator in a top-to-bottom manner, and then be connected to the end loads.

(6) AIM-M300/SG insulation monitor 21, 22 terminals for the over-temperature alarm relay, access to the fan needs external power supply, when more than one transformer is centrally installed in an

isolated power supply cabinet, more than one fan should be connected to parallel control by more than one insulation monitor, that is, each 1 insulation monitor can start and stop all the fans. 23, 24 terminals for the fault alarm relay can be Terminals 23 and 24 are fault alarm relays, which can be connected to an external audible and visual alarm or lead the signal out to the intelligence panel.

(7) Terminals 15 and 16 of AIM-M300/SG insulation monitor are RS485 communication terminals for communication with AID150, and AID150 can connect to 16 AIM-M300/SG. Terminals 18 and 19 of AIM-M300/SG insulation monitor are CAN communication terminals for communication with AID200, and AID200 can connect to 16 AIM-M300/SG. Up to 16 AIM-M300/SG can be connected to the AID200. The AID150/200 can be mounted on a cabinet door, operating room or nurse station wall.

5.5 Considerations

(1) Medical IT system insulation monitoring and fault location six-piece products, except AID150/200, should be centrally installed in the isolated power cabinet. If the site space is limited and can not be used to isolate the power cabinet, the isolation transformer can be installed separately, but should not be too far away from the insulation monitor and the site load.

(2) Installation and wiring should be strictly in accordance with the wiring diagram for wiring, wiring is best to use the needle sleeve connector crimp, and then inserted into the device corresponding terminals and tighten the screws, to avoid poor contact and lead to the device does not work properly.

(3) The grounding wires of both the device and the transformer should be reliably connected to the equipotential terminal block at the site. When the isolated power cabinet is used, it should be connected to the grounding terminal block inside the isolated power cabinet first, and then uniformly connected to the equipotential terminal block on site.

(4) AIM-M300/SG Medical Intelligent Insulation Monitor current input to be used to support the AKH-0.66P26 type current transformer, wiring is recommended to be wired with a U-type crimp crimp, and then connected to the CT terminal, do not directly connect the bare wire head to ensure reliable connection, but also to facilitate disassembly. Before removing the wiring, the CT primary circuit must be cut off or the secondary circuit must be shorted.

(5) Special Reminder:

Any isolation transformer will generate inrush current during startup, and the excessive inrush current may cause the circuit breaker on the primary side of the transformer to disconnect or close with difficulty, therefore, for the medical IT system which is composed of medical isolation transformer and insulation monitoring products, when selecting the circuit breaker for the incoming circuit of the isolation transformer, the circuit breaker with short-circuit protection only and without overload protection shall be selected in accordance with the requirements of the national standard. If the circuit breaker with overload protection is selected, it should be selected in accordance with the national standard C, D release curve of the circuit breaker, and the rated current of the circuit breaker is determined according

to the capacity of the isolation transformer in accordance with the following correspondences: 10kVA-63A; 8kVA-50A; 6.3kVA-40A; 5kVA-40A; 3.15kVA-20A. If the circuit breaker is not selected in accordance with the above requirements, the circuit breaker will not be used in accordance with the requirements of the national standard, and it will not be used in accordance with the requirements of the national standard. above requirements to select circuit breakers, the Company shall not be responsible for any medical accidents caused by difficulties in closing the circuit breakers or disconnection during operation.

6 Programming and Application

6.1 Panel Description

6.1.1 Panel Description of AIM-M300/SG Insulation Monitor

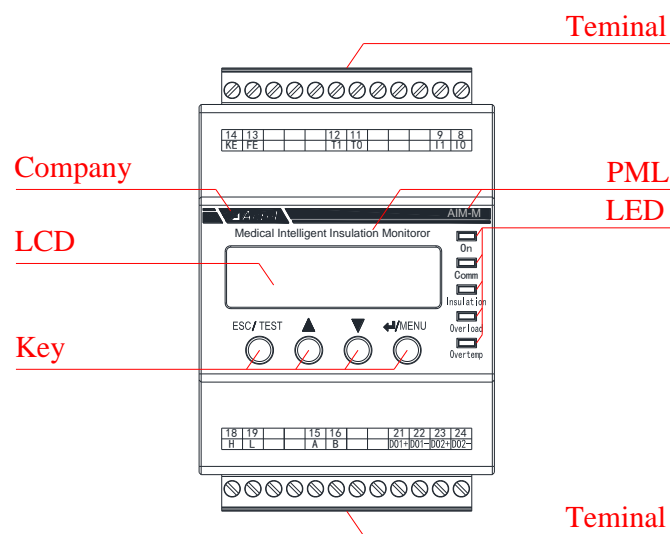

6.1.2 Panel Description of AIL160-6 Insulation Fault Locator

The panel of the AIL160-6 contains 10 sets of dip switches when the cover door for the dip switches is opened. See the diagram below for details:

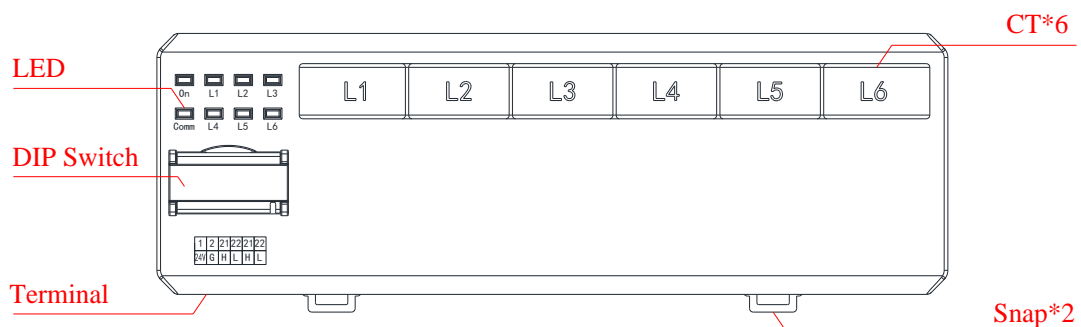

6.1.3 Panel Description of AID150/200 Centralized Alarm and Display Device

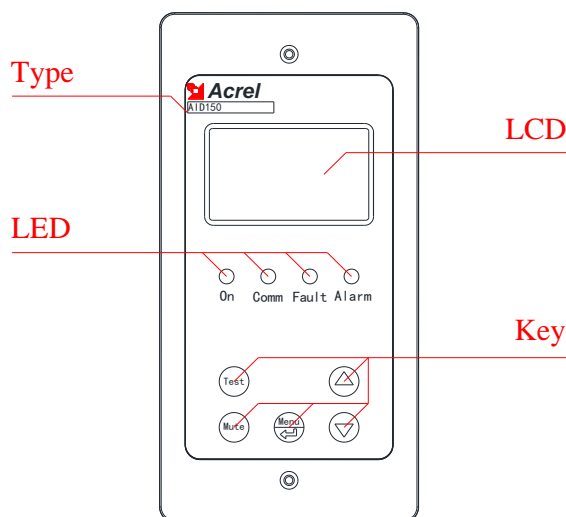

6.2 LED Indicator Instructions

6.2.1 LED indicator instructions of AIM-M300/SG insulation monitoring device

Indicator	Instructions
On	When the device operation is normal, the indicator light flashes, with the flashing frequency of about one time per second.
Comm	Indicate the status of device communication, when there is data communication, the indicator light flashes.
Insulation	When the insulation resistance exceeds the alarm value, or when the LL/FK is disconnected, the indicator light flashes to alarm.
Overload	When load current exceeds the total load current of transformer, the indicator light flashes to alarm.
Overtemp	When testing transformer temperature exceeds the alarm value, or when the temperature sensor wiring is disconnected, the indicator light flashes to alarm.

6.2.2 LED indicator instructions of AIL150/160 Insulation Fault Locator

Indicator status	Instructions
On	When the device operation is normal, the indicator light flashes, with the flashing frequency of about one time per second.
Comm	Indicate the status of device communication, when there is data communication, the indicator light flashes.
L1~L8, L1~L6	Indicate the circuits of the insulation fault

6.2.3 LED indicator instructions of AID150 Centralized Alarm and Display Device

Indicator status	Instructions
On	When the device is in normal operation, the indicator flashes, and the flickering frequency is about once a second.
Comm	Indicate the status of device communication, when there is data communication, the indicator light flashes.
Fault	When AIM series monitor detect disconnection failure, indicator flashes alarm
Alarm	When AIM-M series monitor exceed threshold alarm, indicator flashing alarm

6.2.4 LED indicator instructions of AID200 Centralized Alarm and Display Device

Indicator status	Instructions
On	When the device is in normal operation, the indicator flashes.
Insulation	When the insulation resistance exceeds the alarm value, the indicator light flashes.
Overload	When load current exceeds the total load current of transformer, the indicator light flashes.
Overtemp.	When testing transformer temperature exceeds the alarm value, the indicator light flashes.

6.3 Button Function Descriptions

6.3.1 Button function descriptions of AIM-M300/SG Insulation Monitoring Device

AIM-M300/SG Insulation Monitor has four keys, which are "ESC/TEST" key, "▲" up key, "▼" down key and "↵/Menu" key.

Buttons	Button function
"ESC/TEST" key	In the running state, it is used to start the self-test function of the device; In other states, it is used to return to the function.
"▲" up key, "▼" down key	In non-programming mode, it is used to view fault records, version signals; In programming mode, for increasing or decreasing values, digits or changing the protection action status.
"↵/Menu" key	In non-programming mode, press this key to enter programming mode; In programming mode, when the confirmation key is used.

6.3.2 Button function descriptions of AID150/200 Centralized Alarm and Display Device

AID150/200 Centralized Alarm and Display Device has five keys, which are "TEST" key, "MUTE" key, "Menu/↵" key, "▲" up key and "▼" down key.

Buttons	Button function
"TEST" key	In non-programmed mode, used to start the meter self-test function; In other states, it is used to return to the function.
"MUTE" key	When an alarm is generated, press this key to silence the alarm sound.
"Menu/↵" key	In non-programming mode, press this key to enter programming mode; In programming mode, use it as a carriage return confirmation key.
"▲" up key, "▼" down key	Non-programmed mode for viewing fault records and switching pages; In programmed mode, for increasing or decreasing the number of digits.

6.4 Button Operation Descriptions

6.4.1 Key Operation of AIM-M300/SG Insulation Monitor in RUN Mode

(1) Enter RUN mode. The default mode entered by power-on is RUN mode. After the LCD displays the software version number, if no other key operation is performed, the system enters RUN mode and runs. The main interface displays insulation resistance value, temperature value, current value, load rate and current system time.

(2) Check the alarm record. In the main interface, press "▼" down key to enter the "fault record" interface, press "Menu/↵" key to confirm, then you can query each fault record in turn through the "▲" up key and "▼" down key to turn the page. Press "Menu/↵" key to confirm, then you can use "▲" up key and "▼" down key to turn the page and query each fault record in turn. The first record is the latest record and the tenth record is the earliest record.

(3) View software version information. In the main interface, press the "▼" key twice consecutively to see the software version information.

(4) Register the address (CAN communication address) with AID200. When AIM-M300/SG is used together with AID200, if AIM-M300/SG did not successfully register the address to AID200 when powering up, it needs to register manually. In the main interface, press "▼" three times in succession to

enter the interface of registering address with AID200, and then press the Enter key to realize address registration, and then return to the main interface automatically after registration. If the registration is successful, the CAN communication indicator will start blinking, indicating normal communication.

(5) Device self-test. In the main interface, press the "ESC/TEST" key, the insulation monitor will start the self-test program, simulating overload faults, insulation faults and over-temperature faults, in order to detect the device on the detection of the main faults and determine whether the function is normal. If the monitor can detect the above three kinds of faults, it indicates that the device functions normally.

6.4.2 Key Operation of AIM-M300/SG Insulation Monitor in Programming Mode

(1) Entering Programming Mode

Under normal operation, press "↵/Menu" key to enter the password input page of programming mode. Change the password by "▲" up key or "▼" down key, after inputting the correct password, press "↵/Menu" key, then you can enter the programming mode.

(2) Exit Programming Mode

In programming mode, press the "ESC/TEST" key to enter the exit save confirmation menu, select [Y!] or [N!] by "▲" up key or "▼" down key, then press the "↵/Menu" key to exit the programming module and return to the main interface. "↵/Menu" key, then you can exit the programming module and return to the main interface. If [Y!] is selected before exiting, the setting of the parameter is saved when exiting; if [N!] is selected, the setting of the parameter is not saved before exiting.

(3) System Password Setting

In programming mode, select [Set Misc.] by "▲" up key or "▼" down key, press "↵/Menu" to enter other settings, and then press "▲" up key or "▼" down key to enter other settings. Press "▲" up key or "▼" down key to highlight the numeric part of the password, and press "↵/Menu" to confirm the modification, then you can change the password by pressing "▲" up key or "▼" down key. Press "▲" up key or "▼" down key to change the password, and then press "↵/Menu" to confirm the change. After that, press "↵/Menu" again to confirm, and then press "ESC/TEST" to save and exit the programming mode. The operation example is as follows:

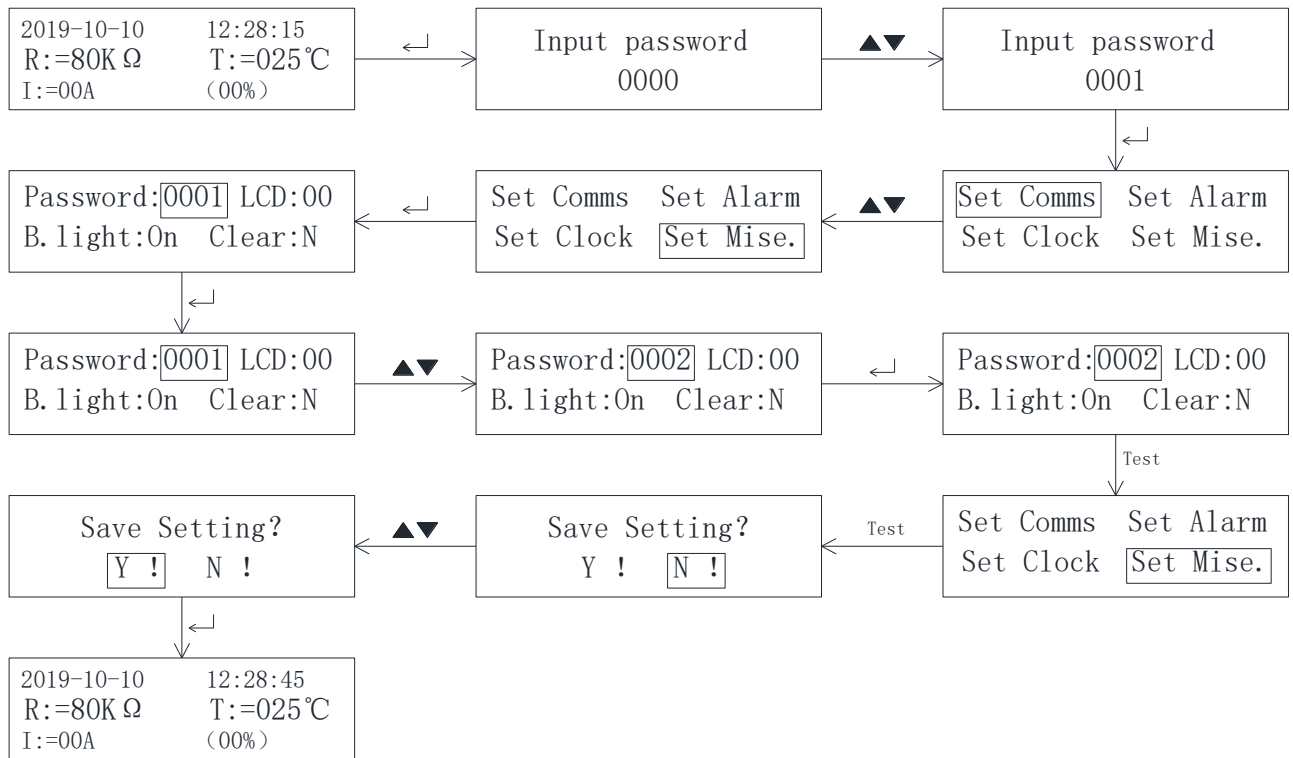

(4) Alarm parameter setting

Alarm parameter is the system insulation alarm value, load current alarm value and transformer temperature alarm value of the size of the settings, and the "Set Mise." setup steps are similar. The following is only on the insulation warning value, current warning value and temperature warning value settings for programming examples.

Set the insulation warning value to 50kΩ, the current warning value to 14A and the temperature warning value to 70°C. The procedure is as follows:

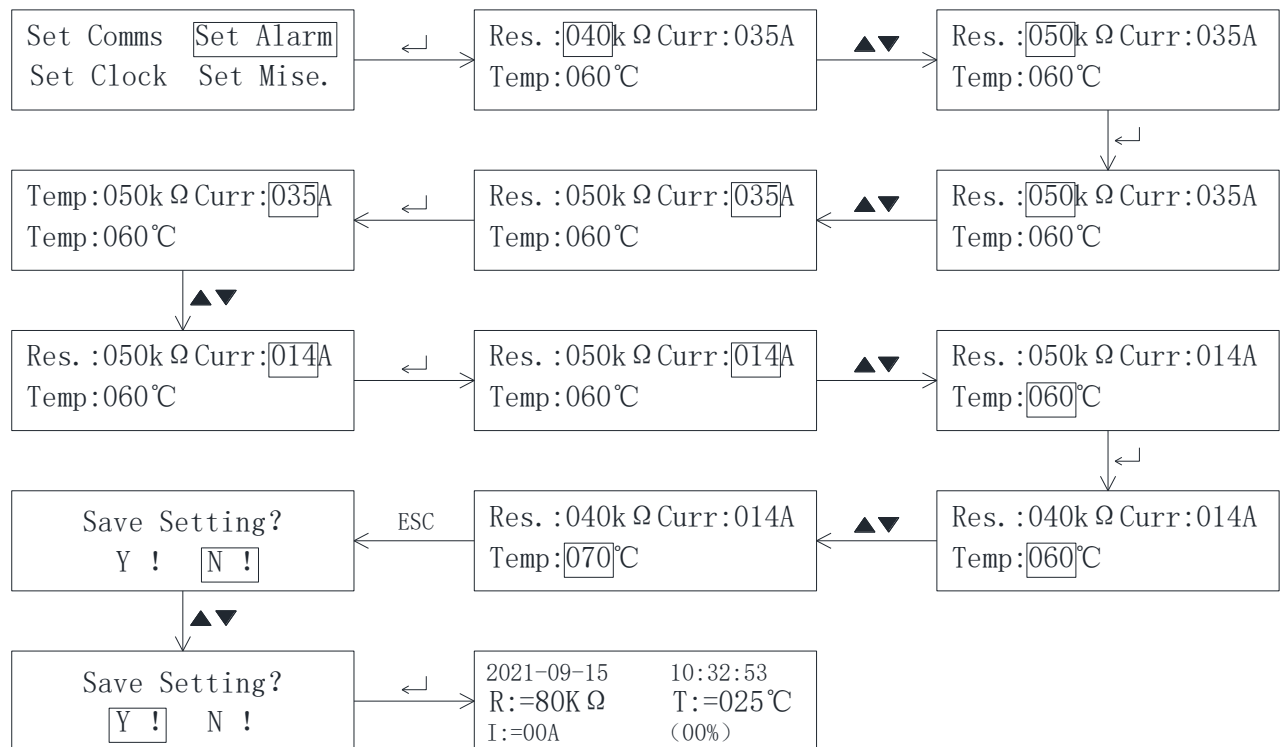

(5) Communication Settings

Communication settings include RS485 communication settings and CAN communication settings, RS485 communication settings include setting the communication address and communication baud rate, CAN communication settings can be set to set the communication address, and can also set whether the device is equipped with a fault locator. Now, the RS485 communication address is set to 005, and the main BAUD is set to 9600 bps. CAN communication address is set to 003 with fault locator. Programming example is as follows:

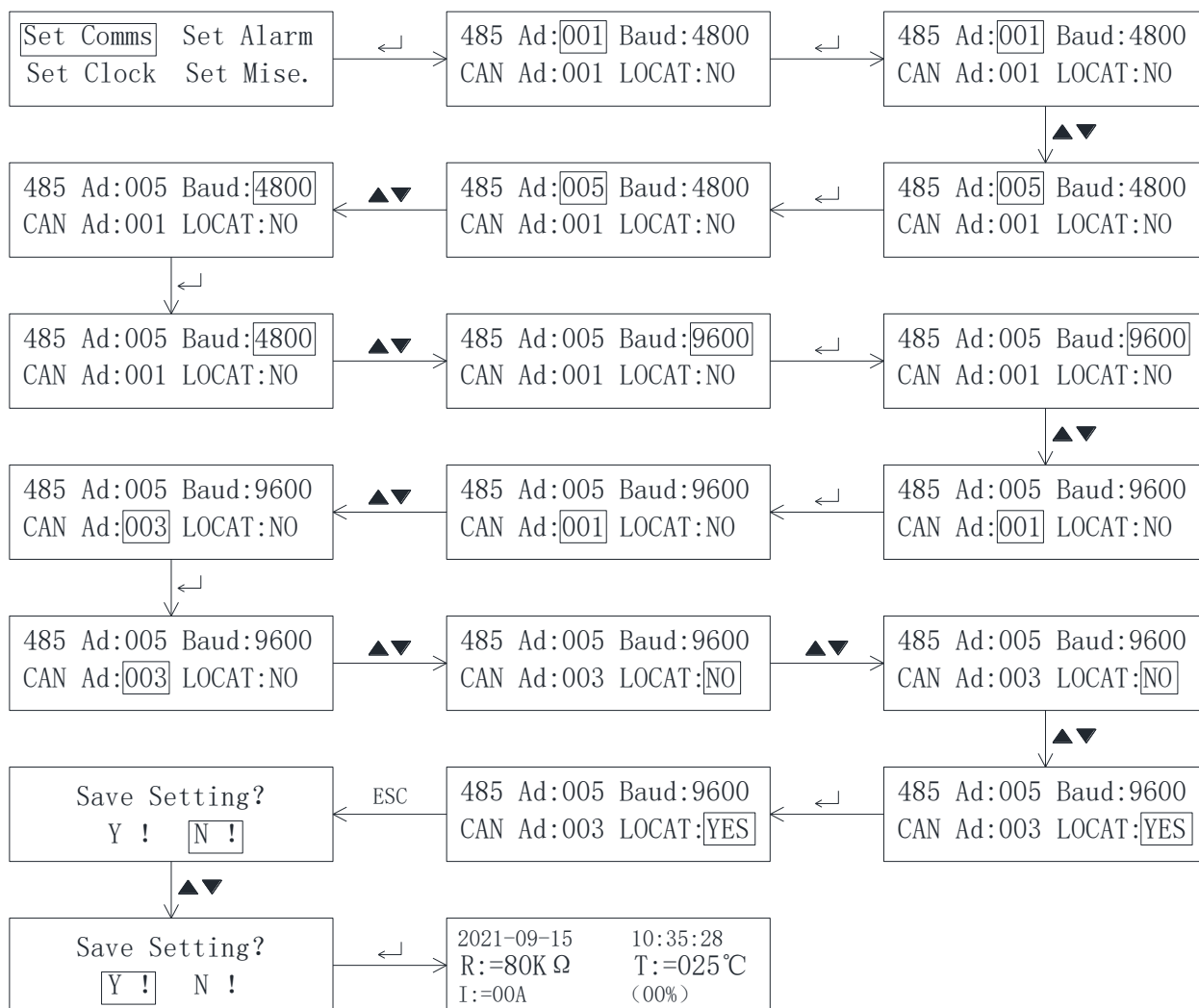

(6) Other parameter settings.

Other parameter settings include contrast settings, backlight time settings and clear the fault record, the setting method and the system password setting method is similar, will not repeat here.

Note: AIM-M300/SG default parameters, RS485 address is 1, baud rate is 9600, CAN address is 1, LOCAT is YES, insulation fault alarm value is 50kΩ, rated current is defaulted according to the transformer capacity, and overtemperature is 70°C.

6.4.3 Key Operation of AID150/200 Centralized Alarm and Display Device

(1) Explanation of operation interface

After the system is powered on, if there is no fault alarm, AID150/200 will display the normal

operation interface as shown in the following figure, the small box filled in black in the figure indicates that the corresponding address number of the corresponding position serial number of the device is connected to the communication, and the small box not filled in black indicates that there is no device connection, or the communication is not connected. When the insulation monitor or residual current monitor monitors the fault, AID150 displays the corresponding alarm interface and issues the corresponding sound and light alarms. AID200 displays the alarm interface of the insulation monitor.

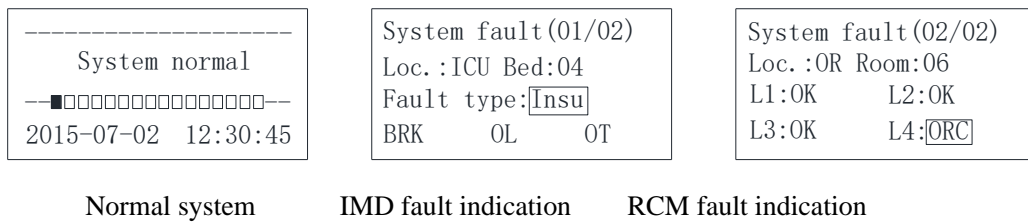

(2) Fault record viewing interface operations and descriptions

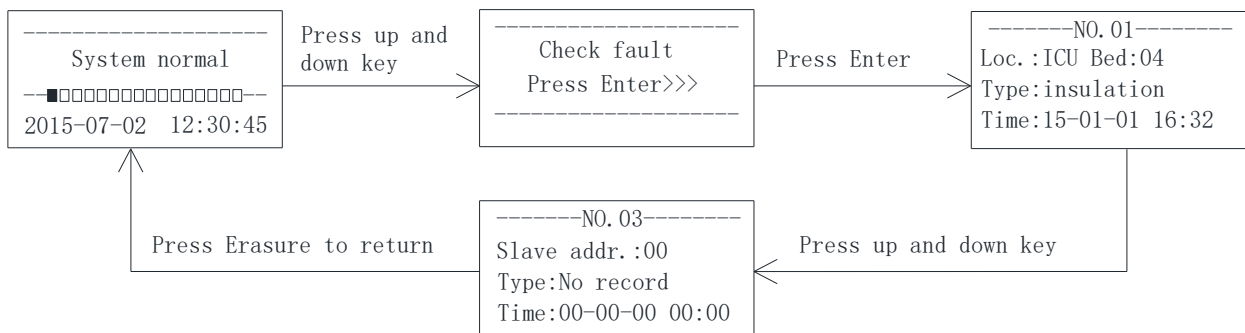

(3) Programming Interface Operation and Explanation

The operation method and process are shown in the following flow chart.

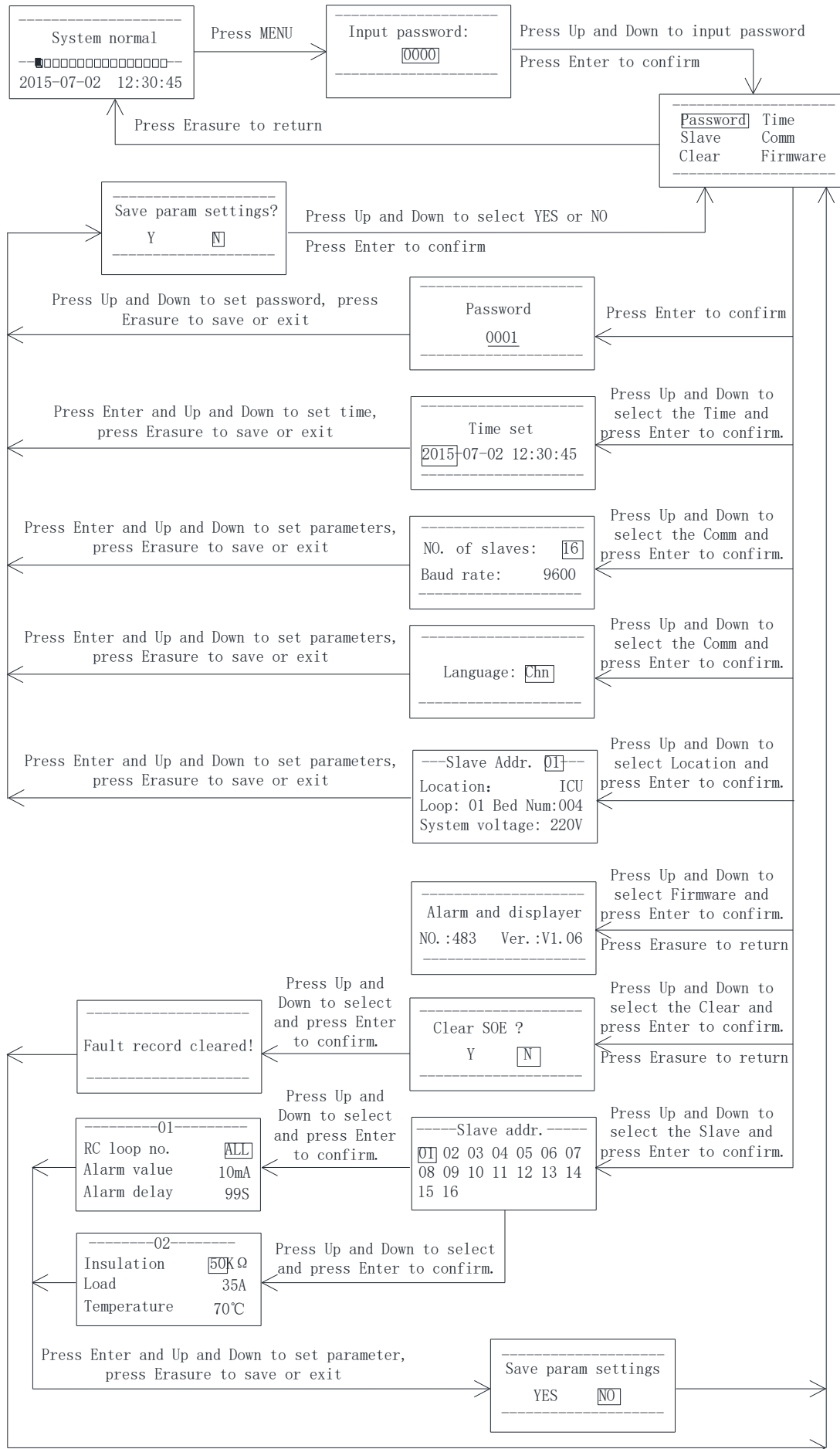

7 Communication Protocol

7.1 Modbus-RTU Communication Protocol

Meter RS485 interface adopts Modbus-RTU communication protocol, which defines the address, function code, data, check code in detail. It is the necessary content to complete the data exchange between the host and slave machine.

7.2 Introduction of Function Code

7.2.1 Function code 03H or 04H: Read the registers

This function allows the user to acquire the data collected and recorded by equipment and the system parameters. The number of data requested by hosts has no limit, but cannot exceed the range.

The following example shows how to read a measured insulation resistance value from 01 slave computer, with the address of the value of 0008H.

The host computer sends		Send message	The slave computer returns		Return message
Address code		01H	Address code		01H
Function code		03H	Function code		03H
Start address	High byte	00H	Bytes		02H
	Low byte	08H	Register data	High byte	03H
Number of registers	High byte	00H		Low byte	E7H
	Low byte	01H	CRC check code	Low byte	F8H
CRC check code	Low byte	05H		High byte	FEH
	High byte	C8H			

The reading result returned from the slave is: 0x03E7H, decimal 999, indicating that the insulation resistance value is 999kΩ.

7.2.2 Function code 10H: Write the registers

The function code 10H allows the user to change the contents of multiple registers, which can write the time and date in this meter. The host can write up to 16 (32 bytes) data at a time.

The following example shows a preset address of 01 with an installation date and time of 12:00, Friday, December 1, 2009.

The host computer sends		Send message	The slave computer returns		Return message
Address code		01H	Address code		01H
Function code		10H	Function code		10H
Start address	High byte	00H	Start address	High byte	00H
	Low byte	04H		Low byte	04H
Number of registers	High byte	00H	Number of registers	High byte	00H
	Low byte	03H		Low byte	03H
Number of registers		06H	CRC check code	Low byte	C1H
0004H data	High byte	09H		High byte	C9H
	Low byte	0CH			
0005H data	High byte	01H			

	Low byte	05H
0006H data	High byte	0CH
	Low byte	00H
CRC check code	Low byte	A3H
	High byte	30H

7.3 Parameter Address Table of AIM-M300/SG

No.	Address	Parameter	Read/Write	Value Range	Data Type
0	0000H	Passwords	R/W	0000~9999 (Default 0001)	UINT16
1	0001H high	RS485 address	R/W	1~247 (Default 1)	UINT16
	0001H low	RS485 baud	R/W	1~4: 4800, 9600, 19200, 38400 (unit bps) (Default 9600)	
2	0002H high	CAN address	R/W	1~110 (Default 1)	UINT16
	0002H low	Fault location function	R/W	0: no; 1: yes (Default 1)	
3	0003H high	LCD contrast	R/W	00~63 (Default 0)	UINT16
	0003H low	Backlight time	R/W	0: Normally open, 1~99 (Unit Min)	
4	0004H high	Year	R/W	1~99, Add 2000 for year	UINT16
	0004H low	Month	R/W	1~12	
5	0005H high	Day	R/W	1~31	UINT16
	0005H low	Week	R/W	1~7	
6	0006H high	Hour	R/W	0~23	UINT16
	0006H low	Minute	R/W	0~59	
7	0007H high	Second	R/W	0~59	UINT16
	0007H low	Reserved			
8	0008H	Insulation resistance	R/W	10~999 (Unit kΩ)	UINT16
9	0009H	Load current	R/W	0~500(Unit 0.1A)	UINT16
10	000AH	Transformer temperature	R/W	-50~200 (Unit is°C)	INT16
11	000BH high	Fault loop	R	0~48 (normal is 0)	UINT16
	000BH low	Fault type	R	bit7: 0 normal; 1 Device fault bit6: 0 normal; 1 CT disconnection bit5: 0 normal; 1 Temp sensor disconnection bit4: 0 normal; 1 FE or KE disconnection fault bit3: 0 normal; 1 L1 or L2 disconnection fault bit2: 0 normal; 1 Transformer overheat fault bit1: 0 normal; 1 Overload fault bit0: 0 normal; 1 Insulation resistance fault For example, 04 01 is 0000 0100 0000 0001; Indicates loop 4 fault, insulation fault	
12~15	000CH~000FH	Reserved			UINT16 *4
16	0010H	Insulation resistance set value	R/W	10~999 (Unit kΩ) (default 50)	UINT16
17	0011H	Current set value	R/W	0~50 (Unit A) (default 35)	UINT16
18	0012H	Transformer temperature set value	R/W	0~200 (Unit °C) (default 70)	UINT16
19~22	0013H~0016H	Reserved			UINT16 *4

23	0017H high	Reserved			UINT16	
	0017H low	SOE parameters	control	R		The storage number of next SOE
24	0018H high	SOE1	Reserved		UINT16	
	0018H low		SOE1 information	R		SOE1 type: 0~7 0: No fault record 1: Insulation fault 2: Overload fault 3: Over temperature fault 4: LL disconnection 5: FK disconnection 6: TC disconnection 7: CT disconnection
25	0019H high		Year	R	SOE1 time - year	UINT16
	0019H low		Moth	R	SOE1 time - month	
26	001AH high		Day	R	SOE1 time - day	UINT16
	001AH low		Hour	R	SOE1 time - hour	
27	001BH high		Minute	R	SOE1 time - minute	UINT16
	001BH low		Second	R	SOE1 time - second	
28~103	001CH~0067H		Store the other 19 SOE records in the same format as the first one			UINT16*76

7.4 CAN Communication Description

In communication, data frame can be divided into multiple segments with different roles. Except for the data segment, the mean of the other segments have been explained in the previous section, so this section will not go into details, and only the data segment information is introduced in this section.

This section only describes the information of the data segment. The bits of the examples given in this section are in hexadecimal. The data segment adopts the format of command and data.

(1) Startup command: 01 01

Description: When the AIM-M300/SG Insulation Monitor monitors an insulation fault in the isolated power system, it will issue a start command to activate the AIL150/160 Fault Locator. After receiving this command, the fault locator will start the insulation fault localization.

(2) Return fault location result command: 04 01

Description: After the AIL150/160 insulation fault locating is completed, the locating result will be sent to AIM-M300/SG Medical Intelligent Insulation Monitor to complete the insulation fault locating.

8 Typical Applications

Products Applications of 6-Piece set in Operating Room

9 Powerup and Debugging Instructions

9.1 Wiring Check

Every IT system should be wired before powering up, mainly to check that there are no misconnections, omissions or short connections. It can be checked in the following order against the wiring diagram shown in part 5.4 of this manual:

(1) Check that each six-piece set constitutes an independent IT distribution system, and ensure that the current, resistance and temperature signals monitored by each insulation monitor are wired to the same isolation transformer and its constituent IT system.

(2) Check whether the L and N inputs of the HDR-60-24 power supply module in each set are connected to the 0 and 230V terminals on the primary side of the isolation transformer. Whether the +V and -V of its 24V output are reliably connected to terminals 1 (24V) and 2 (G) of AIM-M300/SG, terminals 1 (24V) and 2 (G) of AIL150/160, and terminals 24V and G of AID150/200, and whether the positive and negative poles are correct, respectively.

(3) Check whether terminals 8 (I0) and 9 (I1) of AIM-M300/SG in each system are reliably connected to the terminals of the transformer AKH-0.66P26 connected to the secondary side of the corresponding isolation transformer and not grounded, and that the transformer passes through one of the two wires of the isolation transformer output only.

(4) Check that terminals 11 (T0) and 12 (T1) of the AIM-M300/SG in each system are connected to the two ST terminals of the isolation transformer and are reliably connected.

(5) Check whether terminals No. 4 (L1) and No. 5 (L2) of AIM-M300/SG in each system are reliably connected to the two wires of the IT system (i.e. the secondary side of the isolation transformer).

(6) Check whether terminals No. 13 (FE) and No. 14 (KE) of the AIM-M300/SG in each system are connected to the equipotential terminal block on site with wires respectively, and whether terminal S of the isolation transformer is reliably connected to the equipotential terminal block.

(7) Check whether terminals 18 (H) and 19 (L) of CAN communication of AIM-M300/SG in each system are reliably connected with terminals 21 (H) and 22 (L) of AIL150/160 and terminals 21 (H) and 22 (L) of AID200 in a hand-in-hand manner, and whether there is no error in the positive and negative.

(8) If each isolation transformer has a cooling fan, check that the control for that cooling fan power supply is connected to terminals 21 and 22 of the AIM-M300/SG in that set.

(9) Finally, check that both wires supplying power to each branch load in each IT system are routed from top to bottom through the transformer in the AIL150/160 device panel.

9.2 Common Faults and Eliminations

Ensure that the wiring is correct, power up the system. After powering on the system, check whether each device is abnormal, whether AIM-M300/SG medical intelligent insulation monitor has fault alarms, for common problems, you can judge the cause and troubleshoot according to the phenomenon of each

device and the type of fault:

Device name	Fault phenomenon	Possible causes and troubleshooting
AIM-M300/SG Insulation Monitor	LCD: LL open, insulation indicator lights up	Terminals 4 and 5 of the AIM-M300/SG Insulation Monitor are not reliably connected to the two wires at the output of the isolation transformer, check the wiring and make sure it is reliably connected.
	LCD: FK open, insulation indicator lights up	Terminals 13 and 14 of the AIM-M300/SG Insulation Monitor are not reliably connected to the equipotential terminal block, check the wiring and make sure it is reliably connected.
	LCD: CT open, overoad indicator lights up	Terminals 8 and 9 of the AIM-M300/SG Insulation Monitor are not reliably connected to the two terminals of the current transformer, check the wiring and make sure it is reliably connected.
	LCD: TC open, overtemp indicator lights up	Terminals 11 and 12 of the AIM-M300/SG Insulation Monitor are not reliably connected to the two ST terminals of the isolation transformer, check the wiring and make sure it is reliably connected.
	LCD:insulation; insulation indicator lights up	A ground fault on at least one of the two wires of the IT system on the secondary side of the isolation transformer can be removed and returned to normal.
	meter not working	The 24V working power supply of the AIM-M300/SG insulation monitor is not connected properly, check the wiring of terminals 1 and 2 and make sure they are connected reliably.
HDR-60-24 DC Power	power supply not working	Check that the 220V power input wiring is normal and that the voltage between the two terminals is within the allowable input range.
AIL150-4 /AIL150-8 /AIL160-6 Fault Locator	meter not working	The 24V operating power supply is not connected, check whether the wiring of terminals 1 and 2 is normal and rewire.
	Cannot be localized in case of insulation failure	(1)The communication line with other devices in the system is not connected properly, check the communication line and make sure whether the matching resistor is connected properly. (2)CAN address is not set properly, need to disconnect the CAN bus of other system devices connected to it, and then reset the CAN address through the insulation monitor corresponding to it. Device problems, need to return to the manufacturer.
AID150/200 Alarm and Display Device	meter not working	The 24V operating power supply is not connected properly, check if the 24V and G terminal wiring is normal and rewire.
	Comm indicator does not flash	(1) Communication parameters are not set, check the communication parameters (address, baud rate) (2) The communication line with other devices in the system is not connected properly, check the communication line and make sure the matching resistor is connected properly.

9.3 Settings and Debugging

(1) Anchorage medical IT products need to enter a password when entering the menu settings, and the initial password for medical IT products is 0001.

(2) Load current setting. After the power distribution system is normally powered on, you need to set the AIM-M300 load current alarm value according to the capacity of the isolation transformer, the correspondence between the alarm current and the capacity of the isolation transformer is as follows: 45A---10kVA, 35A---8kVA, 28A---6.3kVA, 14A---3.15kVA. After setting, you need to exit step by step,

and then save the setting parameters. The default current alarm value of the instrument is 35A, if the matching transformer is 8kVA, the parameter is not set.

(3) Insulation fault localization function. Enter the communication setting menu of AIM-M300/SG, set the LOCAT item to YES, exit and save to start the function, which is turned on by factory default.

(4) CAN communication address setting. In order to ensure the realization of the fault location function, it is necessary to set the CAN communication address of the AIM-M300/SG, and set the CAN communication address of the AIL150/160 through this operation. Before setting, make sure that the CAN bus wiring of AIM-M300/SG and AIL150/160 within the same IT system is correct. Power on the system, then enter the communication setting menu of AIM-M300/SG, set the CAN communication address, press the Enter key to confirm, and then press the "Return/Self-test" key to return and save. If the communication indicator of AIL150/160 blinks during the saving process, it means that the CAN address of AIL150/160 has been set successfully, and it is recommended that the number of CAN address starts from 1.

(5) Communication address setting. When AID150/200 alarm and display instrument centrally monitors more than one AIM-M300/SG insulation monitor, it is necessary to set the RS485/CAN communication address of AIM-M300/SG in sequence, and the address setting should start from 1, and the maximum number of addresses should not exceed 16.

(6) System quantity setting. When AID150/200 is connected to "N" insulation monitors, it is necessary to set "Number of systems" in AID150/200 settings to "N". When the number of insulation monitors exceeds 16, AID150/200 should be increased for network monitoring.

(7) Communication view and debugging. After setting the address and system number to check the communication status, AID150/200 operation interface can display the communication status of the access insulation monitor, if it shows "□", it means that the corresponding address communication failure, if it shows "■", it means that the corresponding address communication success, if communication failure, you need to check whether the communication bus connection is reliable, if more than one insulation monitor can not communicate, you can connect matching resistors in parallel at the first end of the communication bus. If "□" is displayed, it means the communication of the corresponding address has failed, if "■" is displayed, it means the communication of the corresponding address has succeeded. If the communication fails, it is necessary to check whether the connection of the communication bus is reliable.

Headquarters: Acrel Co., Ltd.

Trade Company: Acrel E-Business (Shanghai) Co., Ltd.

Address: No.253 Yulv Road, Jiading District, Shanghai, China

Postcode: 201801

Manufacturer: Jiangsu Acrel Electrical Manufacturing Co., Ltd.

Address: No.5 Dongmeng Road, Dongmeng industrial Park, Nanzha Street, Jiangyin City, Jiangsu
Province, China

TEL./WhatsApp: 0086-188 6162 8731

Web-site: www.acrel-electric.uk/

E-mail: elsie.ren@email.acrel.cn

Postcode: 214405